



Measurement & Control with optimum performance

Since 1986



Temperature Controllers
Process Instruments
Timers & Counters
Power & Energy Meters
Protection Relays

Product
Catalog
2023

User-friendly & accurate solutions

Multispan is a leading company involved in the development and production of PID Temperature Controllers , Power & Energy Meters, Protection Relays, Timers & Counters as well as customised solutions for various industrial applications. As an owner-managed family business, we employ about 300+ staff with 75+ domestic channel sales partner network in India plus product distribution in 25+ countries.

With marked customer orientation, consistently high quality and vast innovation capability, Multispan develops specific solutions for many industries and applications

Our focus

Provide user-friendly accurate solutions in a way it makes a difference for every industry





Infrastructure

Established in 1986, Multispan has grown significantly as a professionally managed organization. The company has a proven track record of performance & quality of its products till date. Over the years, Multispan has developed proficiency in product design, product development and product testing, with vertically integrated manufacturing facility, infrastructure and a cutting edge, 30 member strong R&D division, with over 3000 software applications, 200+ standard products and 100+ customized products.



Electronic Assembly
Fully Integrated SMT Line



Plastic Enclosure Manufacturing
In-house Injection Moulding



Testing & Quality Control

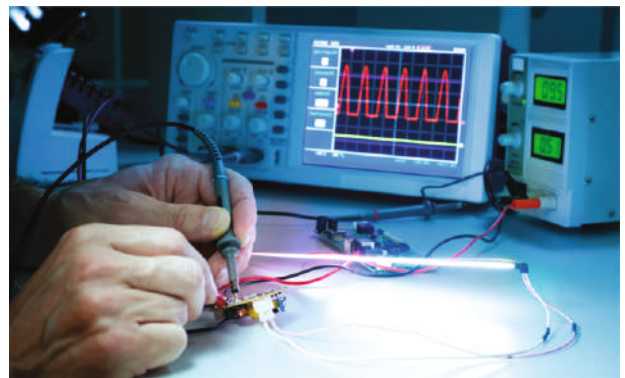

Reliability Laboratory



Applications

Our entire product range has varied industrial applications from complex ones like value controlling to maintain temperature for accurate plastic sealing of food containers to complex IIoT solutions for accurate energy measurement, till serving all kinds of industries

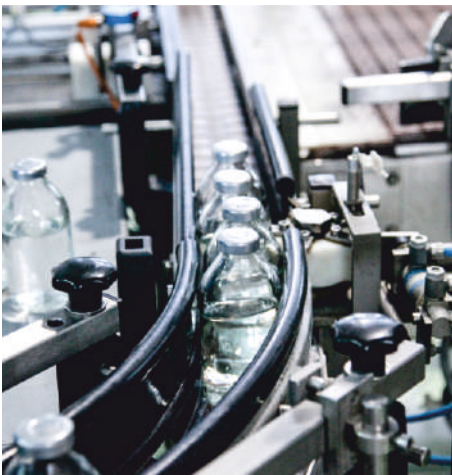

Pharmaceutical



Electrical Panel

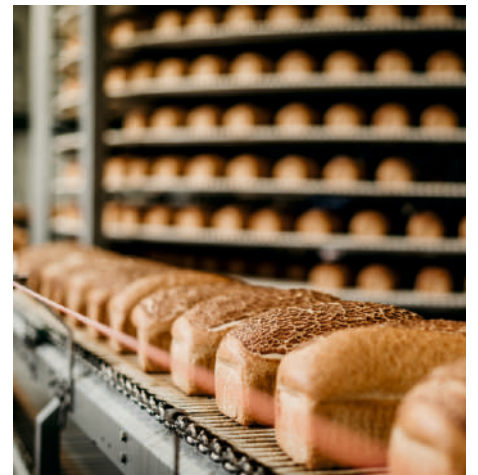

Food Processing



Textile Industry



Packaging



Energy Measurement

INDEX

Process Control Instruments

Pg-01

Temperature Controllers

Pg-08

Cooling Controllers

Pg-17

Programmable Timers

Pg-19

Programmable Counters

Pg-22

Protection Relays

Pg-29

Power & Energy Meters

Pg-39

Jumbo Displays

Pg-46

Process Control Instruments

8 Channel Scanner with RS-485 Modbus Connectivity

8 Channel Indicator



Model	MS-1208	MS-1208A
Dimension (HxWxD)mm	96 x 96 x 54	96 x 96 x 50
Panel Cutout (mm)	92 x 92	92 x 92
INPUT	Inputs	J / K / PT-100 2 Wire or 3 Wire (Configurable)
	Range	J (0°C - 400°C) , K (0°C - 1200°C), PT-100 2 Wire or 3 Wire (-99.9°C - 400.0°C)
OUTPUT	RS-485 Modbus Communication (Optional)	
Accuracy	±1% of FSD	
Supply	100 - 270V AC (SMPS), 50/60Hz	

8 Channel Scanner with RS-485 Modbus Connectivity

Upto 4 Channel Outputs, [Data Logging with Pen Drive Compatibility \(USB\)](#)



Model	MS-1248U	MSU-1248U
Dimension (HxWxD)mm	96 x 96 x 66	96 x 96 x 66
Panel Cutout (mm)	92 x 92	92 x 92
INPUT	Input	J / K / PT-100 2 Wire or 3 Wire (Configurable)
	Range	J (0°C - 600°C) , K (0°C - 1200°C), PT-100 2 Wire or 3 Wire (-99.9°C - 400.0°C, -99.9°C - 400.0°C)
OUTPUT	Output 1	4 Relay with Grouping Facility
	Output 2	RS-485 Modbus Communication (Optional)
	Output 3	USB Port with Data Logging Facility (Optional)
Control Action	ON / OFF	
Accuracy	±1% of FSD	
Supply	100 - 250V AC (SMPS), 50/60Hz	

Process Control Instruments

16 Channel Scanner with RS-485 Modbus & USB Connectivity

Upto 8 Relay Outputs, **Data Logging with Pen Drive compatibility (USB)**



Model	MS-5716RU-M1	
Dimension (HxWxD)mm	192 x 96 x 168	
Panel Cutout (mm)	188 x 92	
INPUT	Sensor	J / K / PT-100 2 Wire or 3 Wire
	Analog	0-10V DC / 4-20mA DC / 0-20mA DC (Configurable)
	Range	J (0°C - 400°C) , K (0°C - 1200°C) , PT-100 2 Wire or 3 Wire (-99.9°C to 400.0°C For Temperature I/P) (-999 to 9999 For analog I/P)
OUTPUT	Output 1	RS-485 Modbus Communication (Optional)
	Output 2	8 Relay with Grouping Facility (Optional)
	Output 3	USB Port with Data Logging Facility (Optional)
Accuracy	±1% of FSD	
Supply	100 - 250V AC (SMPS), 50/60Hz	

Scanner Model Selection Guide

Sr.No.	Model	Channel	Input - 1 J/K/PT-100	Input - 2 4-20mA/0-20mA/0-10V DC	Output Relay	Output RS-485	Output USB Port
1	MS-1208	8	✓				
2	MS-1208-M1	8	✓			✓	
3	MS-1208A	8		✓			
4	MS-1208A-M1	8		✓		✓	
5	MS-1248	8	✓		4		
6	MS-1248-M1	8	✓		4	✓	
7	MS-1248U	8	✓		4		✓
8	MSU-1248	8	✓	✓	4		
9	MSU-1248-M1	8	✓	✓	4	✓	
10	MSU-1248U	8	✓	✓	4		✓
11	MSU-1248U-M1	8	✓	✓	4	✓	✓
12	MSU-1244-M1	4	✓	✓	4	✓	
13	MS-5716	16	✓	✓			
14	MS-5716R	16	✓	✓	8		
15	MS-5716-M1	16	✓	✓		✓	
16	MS-5716U	16	✓	✓			✓
17	MS-5716R-M1	16	✓	✓	8	✓	
18	MS-5716RU	16	✓	✓	8		✓
19	MS-5716U-M1	16	✓	✓		✓	✓
20	MS-5716RU-M1	16	✓	✓	8	✓	✓

Process Control Instruments

Flow Rate Cum Totalizer



Model	MFC-1048 / MFC-1048P	MFC-3016D / MFC-3016A
Dimension (HxWxD)mm	96 x 96 x 50	48 x 96 x 65
Panel Cutout (mm)	92 x 92	46 x 92
INPUT	Input 4 to 20mA DC / 0 to 10V DC / Pulse (Factory Set) Range 0 to 99999999 For Total Flow 0 to 9999 For Flow Rate	
OUTPUT	Output 1 4-20mA DC / 0-10V DC Retransmission (Factory Set) (Optional) Output 2 24V DC Transmitter Supply@30mA (by default) Output 3 1 Relay / 2 Relay 5A, 230V AC (Resistive Load) (1 Relay by default) Output 4 RS-485 Modbus Communication (Optional)	
Accuracy	±1% of FSD	
Supply	100 - 270V AC (SMPS), 50/60Hz or 24V DC (Factory Set)	

Load Cell Indicator / Controller



Model	LD-1252
Dimension (HxWxD)mm	96 x 96 x 54
Panel Cutout (mm)	92 x 92
INPUT	Input 0 - 20mV DC / 0 - 30mV DC from load cell (Factory Set) Range 0 to 99999
OUTPUT	1 Relay & 2 Relay (1 Relay by default) 10V DC@100mA DC Load cell supply (by default) 0 - 10V DC / 4 - 20mA DC Retransmission (Any One Factory Set) (Optional) RS-485 Modbus (Optional)
Accuracy	±0.5% of FSD
Supply	100 to 270V AC (SMPS), 50/60Hz

Process Control Instruments

Signal Isolators



Model	MI-431	MI-532	MI-631 / MI-632
Dimension (HxWxD)mm	100 x 12.5 x 115	100 x 17.5 x 115	76 x 27 x 85
Panel Cutout (mm)	Din Rail Mounting	Din Rail Mounting	Din Rail Mounting
INPUT	Analog : 0 - 20mA DC / 4 - 20mA DC / 0 - 10V DC (Factory set)		0 - 20mA DC / 4 - 20mA DC / 0 - 10V DC / -5 to 5V DC / 0 - 300V DC (Factory Reset) Resistance 2 Wire or 3 Wire port
OUTPUT	0 - 20mA DC / 4 - 20mA DC / 0 - 10V DC, Single Output (Factory Set) 24V DC Transmitter Supply	0 - 20mA DC / 4 - 20mA DC / 0 - 10V DC, Dual Output (Factory Set) 24V DC Transmitter Supply	0 - 20mA DC / 4 - 20mA DC / 0 - 10V DC, (Single Output or Dual Output) (Factory Set)
Accuracy	±0.5% of FSD		
Supply	100 - 270V AC (SMPS), 50/60Hz or 24V DC (Factory Set)		



Model	MI-631T / MI-632T	MI-631P / MI-532P
Dimension (HxWxD)mm	76 x 27 x 85 / 76 x 27 x 85	76 x 27 x 85 / 100 x 17.5 x 115
Panel Cutout (mm)	Din Rail Mounting	Din Rail Mounting
INPUT	Sensor J / K Type	PT-100 2 Wire or 3 Wire
OUTPUT	0 - 20mA DC / 4 - 20mA DC / 0 - 10V DC (Single or Dual Output) (Factory set)	
Accuracy	±1% of FSD	±0.5% of FSD
Supply	100 - 270V AC (SMPS), 50/60Hz or 24V DC (Factory set)	

Process Control Instruments

Voltage & Current Transducers

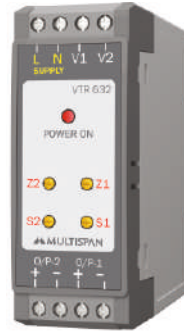

Model	CTR-63 / CTR-632	VTR-63 / VTR-632
Dimension (HxWxD)mm	76 x 27 x 85	76 x 27 x 85
Mounting	Din Rail Mounting	Din Rail Mounting
INPUT	0 to 5A AC, 0 to 1A AC (Factory Set)	AC Voltage
OUTPUT	0 - 20mA DC / 4 - 20mA DC / 0 - 10V DC (Single or Dual Output) (Factory Set)	0 - 20mA DC / 4 - 20mA DC / 0 - 10V DC (Single or Dual Output) (Factory Set)
Accuracy	±1% of FSD	
Supply	100 - 270V AC (SMPS), 50/60Hz / 24V DC (Factory Set)	

Loop Powered Transmitter

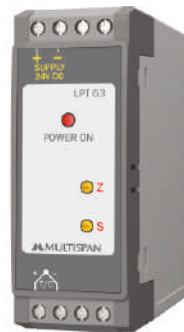

Model	LPT-45	LPT-63
Dimension (HxWxD)mm	Diameter : 45mm	76 x 27 x 85
Panel Cutout (mm)	Head Mounting	Din Rail Mounting
INPUT	Input PT-100 3 Wire / J / K (Factory Set)	Fix Range
	Range PT-100 : 0 to 100 / 0 to 200 / 0 to 300 / 0 to 400 (Configurable) / Fix Range	
OUTPUT	4 - 20mA DC Signal (2 Wire System)	
Supply	24V DC Loop Powered	

Process Control Instruments

Fault Annunciator

Upto 10 Fault Inputs & 3 Outputs

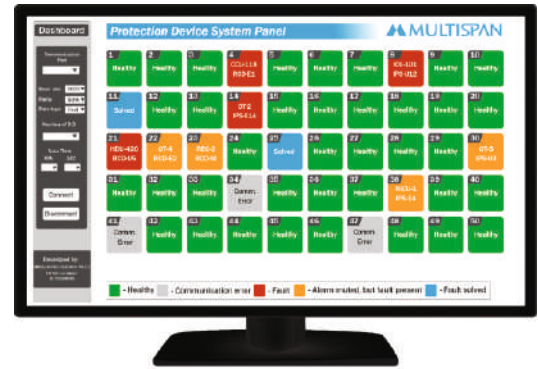

PC INTERFACE SOFTWARE

Model	FA-11 16 X 2 LCD Display
Dimension (HxWxD)mm	96 x 96 x 66
Panel Cutout (mm)	92 x 92
DISPLAY	16 Character by 2 line with Blue back light LCD Display
INPUT	10 Input potential free contact
OUTPUT	3 Relay 1C/O for Audio alarm , Visual alarm & Machine Trip
Supply	100 - 270V AC (SMPS), 50/60Hz (Factory Set)
Indication	1) Audio Alarm 2) Visual Alarm 3) Machine Output
Features	Fault Type NO or NC Configurable, Last 10 fault history saved in memory
Note	RS-232 Serial PC Interfacing to define soft / hard fault, RS-485 Modbus is available as per request

Dual Process Indicator



Model	DPI-122	DPI-1824
Dimension (HxWxD)mm	96 x 96 x 54	96 x 96 x 54
Panel Cutout (mm)	92 x 92	92 x 92
INPUT	Input 1 & 2 PT-100 3 Wire / 4 - 20mA DC / 0 - 20mA DC / 0 - 10V DC (Any two factory set)	J / K / PT-100 2 Wire or 3 Wire 0 - 10V DC / 4 - 20mA DC / 0 - 20mA DC (Configurable)
Range	-999 to 9999 For Analog I/P, PT-100 (0.0 °C - 400.0 °C)	-999 to 9999 for Analog Input J (0 °C to 600 °C) , K (0 °C to 1200 °C), PT-100 2 Wire or 3 Wire (-99 °C to 400 °C, -99.9 °C to 400.0 °C) For Temperature Sensor
OUTPUT	1 Relay / 2 Relay (Optional) 24V DC Transmitter Supply@30mA (Optional) RS-485 Modbus (Optional)	4 Relay + 2 Retransmission + 24V DC Transmitter@30mA DC
Control Action	ON - OFF	
Accuracy	±1% of FSD	
Supply	100 - 270V AC (SMPS), 50/60Hz	

Process Control Instruments

Process Indicators



	Model	PI-38	PI-54	PI-41
Dimension (HxWxD)mm		48 x 96 x 26	38 x 62 x 63	48 x 48 x 46
	Panel Cutout (mm)	46 x 92	31 x 54	45 x 45
INPUT	Input	0 - 10V DC / 0 - 20mA DC / 4 - 20mA DC (Configurable)		
	Range	-999 to 9999 for Analog Input		
Display Resolution		0.000 / 00.00 / 000.0 / 0000 (Configurable , For Analog Input)		
Features		Correction Factor , Offset , Filtration Rate , Reverse Scaling		
Supply		100 - 270V AC (SMPS), 50/60Hz		

Process Controllers



	Model	PIC-1101	PIC-38	PIC-4202
Dimension (HxWxD)mm		96 x 96 x 54	48 x 96 x 54	48 x 48 x 95
	Panel Cutout (mm)	92 x 92	46 x 92	45 x 45
INPUT	Input	0 to 10V DC / 4 to 20mA DC / 0 to 20mA DC (Configurable)		
	Range	-999 to 9999 (Configurable)		
OUTPUT	Output 1	1 Relay (By Default)		2 Relay (By Default)
	Output 2	2 Relay (Optional)		
	Output 3	24V DC Transmitter Supply@30mA (By Default)		24V DC Transmitter Supply@30mA
	Output 4	4 to 20mA / 0 to 20mA DC Retransmission Output (Factory Set) (Optional)		NA
Operating Mode		High / Low / Inband / Outband / Absolute Low / Absolute Outband Alarm (configurable)		
Accuracy		±1% of FSD		
Supply		100 - 270V AC (SMPS), 50/60Hz		

Temperature Controllers

PID Temperature Controller with Built in Ampere Indication



	Model	PID-2302-1C/3C (With CT Module)	PID-4203-1C (With CT Module)
Dimension (HxWxD)mm		72 x 72 x 85	48 x 48 x 111
Panel Cutout (mm)		68 x 68	45 x 45
INPUT	Input	J / K (Configurable) + CT Input	J / K / PT-100 (Configurable)
	Range	J (0 °C to 400 °C), K(0 °C to 500 °C)	J (0 °C to 600 °C), K(0 °C to 1200 °C) PT-100 2 Wire or 3 Wire (-99 °C to 400 °C , -99.9 °C to 400.0 °C)
CT INPUT		1 CT (30A or 60A Rail Mounting) 3 CT (30A or 60A Rail Mounting)	
OUTPUT		2 Relay 1st Relay Parallel SSR + 2nd O/P Relay or SSR (2 Relay 1C/O 5A 230V AC Resistive Load) SSR Drive O/P 24V DC 20mA	3 Relay 1C/O 5A, 230V AC (Resistive Load) or 3SSR Drive O/P 12V DC, 20mA (Factory Set) (3 Set Point) (Heat + Cool + Alarm)
Control Action		PID / ON-OFF (Configurable)	
Accuracy		±1% of FSD	
Supply		100 - 250V AC (SMPS), 50/60Hz	
Note		RS-485 Output available in PID-2303-1C-M1/3C-M1 & Input PT-100 3Wire available in PID-2303-1C/3C as per request	

Motor Synchronizer



Model	SN-126-4
Dimension (HxWxD)mm	75 x 45 x 110
Panel Cutout (mm)	Din Rail Mounting
INPUT	3 Wire / POT Resistance
OUTPUT	1 Relay For Zeroing Facility, 0 - 10V DC (4/5/6) Channel
Supply	230V AC, ±20%, 50Hz

Temperature Controllers

Universal Programmable Controller

Auto Tune PID, RS-485 Modbus Facility



Model	PTC-L12A-M1	UTC-4201A
Dimension (HxWxD)mm	96 x 96 x 54	48 x 48 x 95
Panel Cutout (mm)	92 x 92	45 x 45
INPUT	Input J / K / PT-100 2 Wire or 3 Wire, 0 - 10V DC / 4 - 20mA / 0 - 20mA (Configurable)	J / K / PT-100 2 Wire or 3 Wire
	Range J (0 °C to 600 °C) , K (0 °C to 1200 °C) , PT-100 2 Wire or 3 Wire (-99 °C to 400 °C, -99.9 °C to 400.0 °C) , (-999 to 9999 for Analog Input)	J (0 °C to 600 °C) , K (0 °C to 1200 °C) , PT-100 (-99 °C to 400 °C, -99.9 °C to 400.0 °C)
OUTPUT	Output 1 0 - 10V DC / 4 - 20mA DC / 0 - 20mA DC (Factory Set) (Controlling / Retransmission Selection)	
	Output 2 1 Relay 1C/O 5A,230V AC (Resistive Load) or SSR Drive O/P 12V DC, 20mA (Factory Set)	
	Output 3 1 Relay 1C/O 5A,230V AC (Resistive Load) or SSR Drive O/P 12V DC, 20mA (Factory Set)	NA
Communication	RS-485 Modbus Communication (Optional)	NA
Control Action	PID / ON-OFF (Configurable)	
Accuracy	±1% of FSD	
Supply	100 - 250V AC (SMPS), 50/60Hz	



Model	PTC-1202A-M1	PTC-4202A-M1
Dimension (HxWxD)mm	96 x 96 x 54	48 x 48 x 111
Panel Cutout (mm)	92 x 92	45 x 45
INPUT	Input J / K / PT-100 2 Wire or 3 Wire, 0 - 10V DC / 4 - 20mA / 0 - 20mA (Configurable)	
	Range J (0 °C to 600 °C) , K (0 °C to 1200 °C) , PT-100 2 Wire or 3 Wire (-99 °C to 400 °C, -99.9 °C to 400.0 °C) , (-999 to 9999 for Analog Input)	
OUTPUT	Output 1 1 Relay 1C/O 5A,230V AC (Resistive Load) or SSR Drive O/P 12V DC, 20mA (Factory Set)	
	Output 2 1 Relay 1C/O 5A,230V AC (Resistive Load) or SSR Drive O/P 12V DC, 20mA (Factory Set)	
	Output 3 0 - 10V DC / 4 - 20mA DC (Factory Set) (Controlling / Retransmission Selection)	
Communication	RS-485 Modbus Communication (Optional)	
Control Action	PID / ON-OFF (Configurable)	
Accuracy	±1% of FSD	
Supply	100 - 250V AC (SMPS), 50/60Hz	

PTC Model Selection Guide

Sr. No.	Model	Display	Size (HxWxD)mm	Output 1	Output 2	Output 3	Output RS-485
1	PTC-L12	Graphical LCD	96 x 96 x 54	Relay	Relay	-	-
2	PTC-L12A	Graphical LCD	96 x 96 x 54	4-20mA/0-10V DC	Relay	Relay	-
3	PTC-L12-M1	Graphical LCD	96 x 96 x 54	Relay	Relay	-	✓
4	PTC-L12A-M1	Graphical LCD	96 x 96 x 54	4-20mA/0-10V DC	Relay	Relay	✓
5	PTC-1202	LED	96 x 96 x 54	Relay	Relay	-	-
6	PTC-1202A	LED	96 x 96 x 54	4-20mA/0-10V DC	Relay	Relay	-
7	PTC-1202-M1	LED	96 x 96 x 54	Relay	Relay	-	✓
8	PTC-1202A-M1	LED	96 x 96 x 54	4-20mA/0-10V DC	Relay	Relay	✓
9	PTC-4202	LED	48 x 48 x 95	Relay	Relay	-	-
10	PTC-4202A	LED	48 x 48 x 111	4-20mA/0-10V DC	Relay	Relay	-
11	PTC-4201-M1	LED	48 x 48 x 95	Relay	-	-	✓
12	PTC-4202-M1	LED	48 x 48 x 111	Relay	Relay	-	✓
13	PTC-4202A-M1	LED	48 x 48 x 111	4-20mA/0-10V DC	Relay	Relay	✓

Note : Analog Output 0 - 10V DC or 4 - 20mA DC, any one fixed. Please confirm while order is placed.

Temperature Controllers

Humidity + Temperature Controller



Model	MHC-1101 (Humidity Controller)	MHT-1202 (Humidity + Temperature Controller)
Dimension (HxWxD)mm	96 x 96 x 54	96 x 96 x 54
Panel Cutout (mm)	92 x 92	92 x 92
INPUT	Input	S-1 : PT-100 2 Wire or 3 Wire (RTD) S-2 : Humidity Sensor
	Range	0.0 to 100.0% RH
OUTPUT	1 Relay 1C/O, 5A@230V AC (Resistive Load)	1 st Relay for Temperature and 2 nd Relay for Humidity RS-485 Modbus (Optional)
Control Action	ON - OFF	
Accuracy	±1% of FSD	
Supply	100 - 270V AC (SMPS), 50/60Hz	
Note	RS-485 Modbus Available on request MHT-1202	

9 Stage Profile Controller



Model	PRC-1202	
Dimension (HxWxD)mm	96 x 96 x 110	
Panel Cutout (mm)	92 x 92	
INPUT	Input	J / K / PT-100 2 Wire or 3 Wire (Factory Set)
	Range	J (0 °C to 600 °C), K (0 °C to 1200 °C), PT-100 2 Wire or 3 Wire (-99 °C to 400 °C , 0.0 °C to 400.0 °C)
OUTPUT	2 Relay 1C/O (set point), 2 nd Relay for Alarm	
Control Action	ON - OFF	
Accuracy	±1% of FSD	
Supply	100 - 250V AC (SMPS), 50/60Hz	

Temperature Controllers

Temperature Controller - Universal

Double Display PID Controller - 3 Relay



Model	UTC-4203	UTC-3203
Dimension (HxWxD)mm	48 x 48 x 95	96 x 48 x 85
Panel Cutout (mm)	45 x 45	92 x 45
INPUT	Input	J / K / PT-100 2 Wire or 3 Wire (Configurable)
	Range	J (0°C to 600°C), K(0°C to 1200°C) PT-100 2 Wire or 3 Wire (-99°C to 400°C, -99.9°C to 400.0°C)
OUTPUT	3 Relay 1C/O 5A, 230V AC (Resistive Load) or SSR Drive O/P 12V DC, 20mA (3 Set Point) (Factory Set)	
Control Action	PID / TP / ON-OFF (Configurable)	
Accuracy	±1% of FSD	
Supply	100 - 270V AC (SMPS), 50/60Hz	

Temperature Controllers

Single Display PID - Economy Range



Model	UTC-114	UTC-214	UTC-413P
Dimension (HxWxD)mm	96 x 96 x 43	72 x 72 x 45	48 x 48 x 70
Panel Cutout (mm)	92 x 92	68 x 68	45 x 45
INPUT	Input	J / K / PT-100 2 Wire or 3 Wire (Configurable)	
	Range	J (0°C to 400°C or 0 to 600°C) , K (0°C to 1200°C) , PT-100 2 Wire or 3 Wire (-99.9 to 400.0°C)	J (0°C to 600°C) , K (0°C to 999°C) , PT-100 (-99 to 400°C), PT.1 (-19.9 to 99.9°C)
OUTPUT	1 Relay 1C/O 5A, 230V AC (Resistive Load) & SSR Drive O/P 12V DC, 30mA (Parallel to Relay) (1 set Point)		
Control Action	PID / ON-OFF		
Accuracy	±1% of FSD		
Supply	100 - 270V AC (SMPS), 50/60Hz		

Temperature Controllers

Dual Output & Autotune PID Controller - Full Featured



Model	UTC-1202G	UTC-2202G	UTC-4202G	UTC-3202
Dimension (HxWxD)mm	96 x 96 x 54	72 x 72 x 85	48 x 48 x 95	96 x 48 x 85
Panel Cutout (mm)	92 x 92	68 x 68	45 x 45	92 x 45
INPUT	Input	J / K / PT-100 2 Wire or 3 Wire (Configurable)		
	Range	J (0°C to 600°C, 0.0°C to 400.0°C), K (0°C to 1200°C, 0.0°C to 500.0°C), PT-100 2 Wire or 3 Wire (-99°C to 400°C, -99.9°C to 400.0°C)		
OUTPUT	2 Output : (SSR parallel to 1 st Relay) + 1 Relay or 1 SSR Drive O/P (2 Relay 1C/O 5A, 230V AC (Resistive Load) & SSR Drive O/P 24V DC, 20mA)			
Operating Mode	Heat / Cool / Alarm			
Alarm	High / Inband / Absolute Low / Absolute Outband / Outband / End Alarm / Low Alarm Outband + Soak Timer			
Control Action	PID / TP / ON-OFF (Configurable)			
Accuracy	±0.5% of FSD			
Supply	100 - 270V AC (SMPS), 50/60Hz			

Temperature Controllers

Single Output + Autotune PID Controller



Model	UTC-121G	UTC-221G	UTC-421G	UTC-321P
Dimension (HxWxD)mm	96 x 96 x 54	72 x 72 x 85	48 x 48 x 95	96 x 48 x 85
Panel Cutout (mm)	92 x 92	68 x 68	45 x 45	92 x 45
INPUT	Input	J / K / PT-100 2 Wire or 3 Wire (Configurable)		
	Range	J (0°C to 600°C, 0.0°C to 400.0°C), K (0°C to 1200°C, 0.0°C to 500.0°C), PT-100 2 Wire or 3 Wire (-99°C to 400°C, -99.9°C to 400.0°C)		
OUTPUT	1 Relay 1C/O 5A, 230V AC (Resistive Load) & SSR Drive O/P 24V DC, 20mA (Parallel to Relay) (1 Set Point)			
Control Action	PID / ON-OFF (Configurable)			
Accuracy	±0.5% of FSD			
Supply	100 - 270V AC (SMPS), 50/60Hz			

Temperature Controllers

Double Display PID Controller



Model	UTC-121P	UTC-221P	UTC-421P
Dimension (HxWxD)mm	96 x 96 x 43	72 x 72 x 45	48 x 48 x 70
Panel Cutout (mm)	92 x 92	68 x 68	45 x 45
INPUT	Input	J / K / PT-100 2 Wire or 3 Wire (Configurable)	
	Range	J (0°C to 600°C), K (0°C to 999°C), PT-100 2 Wire or 3 Wire (-99°C to 400°C) (-19.9°C to 99.9°C)	
OUTPUT	1 Relay 1C/O 5A, 230V AC (Resistive Load) or SSR Drive O/P 12V DC, 30mA (Parallel to Relay) (1 Set Point)		
Alarm	High / Inband / Absolute Low / Absolute Outband / Outband / End Alarm / Low Alarm Outband + Soak Timer		
Control Action	PID / TP / ON-OFF (Configurable)		
Accuracy	±1% of FSD		
Supply	100 - 270V AC (SMPS), 50/60Hz		



Model	TC-421P	TC-442	TC-443
Dimension (HxWxD)mm	48 x 48 x 70	48 x 48 x 70	48 x 48 x 70
Panel Cutout (mm)	45 x 45	45 x 45	45 x 45
INPUT	Input	J / K Type	
	Range	J (0°C to 600°C), K (0°C to 900°C),	
OUTPUT	1 Relay 1C/O 5A, 230V AC (Resis. Load) & SSR Drive O/P 12V DC, 30mA (Parallel to Relay) (1 Set Point)	2 Output : (SSR Parallel to 1 st Relay) + 1 Relay (2 Relay 1C/O 5A, 230V AC (Resis. Load) & SSR Drive O/P 12V DC, 20mA)	3 Output : (SSR Parallel to 1 st Relay) + 2 Relay (3 Relay 1C/O 5A, 230V AC (Resis. Load) & SSR Drive O/P 12V DC, 20mA)
Control Action	PID / ON-OFF (Configurable)		
Accuracy	±1% of FSD		
Supply	100 - 270V AC (SMPS), 50/60Hz		

Temperature Controllers

Digital Temperature Controller (Fixed Input)



Model	TC-19	TC-29	TC-49
Dimension (HxWxD)mm	96 x 96 x 43	72 x 72 x 45	48 x 48 x 70
Panel Cutout (mm)	92 x 92	68 x 68	45 x 45
INPUT	Input	J / K / R / S / PT-100 2 Wire or 3 Wire (Factory Set)	J / K (Configurable) or PT-100 2 Wire or 3 Wire (Factory set)
	Range	J (0°C to 400°C or 0°C to 600°C) , K (0°C to 1200°C), PT-100 2 Wire or 3 Wire (0°C to 400°C, -50.0°C to 200.0°C)	J (0°C to 600°C) , K (0°C to 999°C), PT-100 (-50°C to 400°C)
OUTPUT	1 Relay 1C/O 5A, 230V AC (Resistive Load) or SSR (Factory Set)		1 Relay 1C/O 5A, 230V AC (Resistive Load) or SSR Drive O/P 12V DC, 20mA (Parallel to Relay)
Control Action	TP / ON-OFF (Configurable)	TP / ON-OFF (Configurable)	
Accuracy	±1% of FSD	±1% of FSD	
Supply	230V AC, ±20%, 50Hz	100 - 270V AC (SMPS), 50/60Hz	

PID Temperature Controller Economy Range



Model	TC-29P	TC-221P	TC-49P
Dimension (HxWxD)mm	72 x 72 x 45	72 x 72 x 45	48 x 48 x 70
Panel Cutout (mm)	68 x 68	68 x 68	45 x 45
INPUT	Input	J / PT-100 2 Wire or 3 Wire (Factory Set)	J / K Type
	Range	J (0°C to 400°C) PT-100 2 Wire or 3 Wire (0°C to 400°C)	J (0°C to 400°C), K (0°C to 500°C)
OUTPUT	1 Relay 1C/O 5A, 230V AC (Resistive Load) or SSR Drive O/P 12V DC, 20mA (Parallel to Relay) (1 Set Point)		
Control Action	PID / ON-OFF (Configurable)		
Accuracy	±1% of FSD		
Supply	100 to 270V AC (SMPS), 50/60Hz		



Temperature Controllers

PID Temperature Controller Modules



Master Module

Slave Module

	Model	DTC-1X (Master Module)	DTC-1A (Slave Module)
Dimension (HxWxD)mm		76 x 28 x 141	76 x 28 x 141
Panel Cutout (mm)		Din Rail Mounting	Din Rail Mounting
INPUT	Input	J / K / PT-100 (Configurable)	
	Range	J (0°C to 600°C), K (0°C to 1200°C) PT-100 (-99°C to 400°C, -99.0°C to 400.0°C)	
OUTPUT		2 Relay 1C/O 5A, 230V AC (Resistive Load) or SSR Drive O/P 24V DC, 20mA (2 Set Point)	
	Control Action	PID / TP / ON-OFF (Configurable)	
	Accuracy	±1% of FSD	
	Supply	24V DC (For Master Module)	

Features

MODBUS RS-485 Communication for HMI Indication

Connection Upto 1 Master + 7 Slave Modules

Note

For more than 8 modules, master module can be repeated with 7 slaves



Cryo

A brand by **MULTISPAN**



Model	CC-510	CC-552
Dimension (HxWxD)mm	37 x 78 x 70	37 x 78 x 70
Panel Cutout (mm)	30 x 71	30 x 71
INPUT	Input NTC (Thermistor) Range -40 °C to 90.0 °C	
OUTPUT	1 Relay 1C/O, 10A@230V AC (Resistive Load) (With Defrost Facility)	2 Relay for Compressor
Control Action	ON - OFF (Cooling Mode)	
Supply	230V AC ±20%, 50Hz / 24V DC / 12V DC (Factory Set)	

Humidity Controller



Model	MHC-512
Dimension (HxWxD)mm	37 x 78 x 70
Panel Cutout (mm)	30 x 71
INPUT	Input Humidity Sensor Range 0.0 to 100.0% RH
OUTPUT	2Relay 1C/O, 10A @230V AC (Resistive Load)
Control Action	ON - OFF (Cooling Mode)
Accuracy	±1% of FSD
Supply	230V AC ±20%, 50Hz / 24V DC / 12V DC (Factory Set)

Cryo Model Selection Guide

Sr. No.	Model	Size (HxWxD)mm	Input	Output 1	Output 2
1	CC-510	37 x 78 x 70	NTC (Thermistor)	Relay 10A (1C/O)	-
2	CC-520	37 x 78 x 78	NTC (Thermistor)	Relay 20A (1C/O)	-
3	CC-512	37 x 78 x 70	NTC (Thermistor)	Relay for Compressor 1C/O 10A	Relay for Alarm 1C/O 10A
4	CC-515	37 x 78 x 70	NTC (Thermistor)	Relay for Compressor 1C/O 10A	Buzzer (12V DC)
5	CC-552	37 x 78 x 70	NTC (Thermistor)	Relay for Compressor 1C/O 10A	Relay for Compressor 1C/O 10A
6	CC-521	37 x 78 x 70	NTC (Thermistor)	Relay for Compressor 1C/O 10A	Relay for Heater 1C/O 10A
7	CC-522	37 x 78 x 70	NTC (Thermistor)	Relay for Compressor (NO-C) 20A	Relay for Alarm 1C/O 5A
8	CC-525	37 x 78 x 70	NTC (Thermistor)	Relay for Compressor (NO-C) 20A	Buzzer (12V DC)



**Touch
Key
AVAILABLE**

Programmable Timers

UP to 12 Channel Sequential Timer

With Cascading Facility For 8 + 8 Outputs

4,8 and 12 Channel Sequential Timer



Model	SQT-1044 / SQT-1244 / SQT-1022 Sequential Timer	CMT-1022 / CMT-1044 Combination Timer
Dimension (HxWxD)mm	96 x 96 x 54	96 x 96 x 54
Panel Cutout (mm)	92 x 92	92 x 92
INPUT Range	99.99 Sec / 999.9 Sec / 99.59 Min / 99.59 Hrs / 999.9 Hrs / 999.9 Min (Configurable)	
OUTPUT	4 Relay / 8 Relay / 12 Relay 1C/O 5A,230V AC (Resistive Load) or SSR Drive O/P 24V DC, 20mA Output (Any One Factory Set)	
Operating Mode	Delayed ON / Delayed OFF / Cycle Mode (Configurable)	
Count Direction	UP / Down (Configurable)	
Memory	YES / NO (Configurable)	
Reset	Front & Back Both Reset Available	
Supply	100 - 270V AC (SMPS), 50/60Hz	
Note	Cascading facility available in SQT-1044 (8 Relay) Sequential timer up to 1 + 3 parallel SSR output is available on request Cascading facility available on request in SQT-1022	



Model	RTC-1048
Dimension (HxWxD)mm	96 x 96 x 50
Panel Cutout (mm)	92 x 92
INPUT Range	23:59:59 Hrs / Min / Sec
OUTPUT	1 Relay 1C/O 5A, 230V AC (Resistive Load)
Parameter	ON Time / OFF Time (16 Program)
Supply	100 - 270V AC (SMPS), 50/60Hz

Programmable Timers

Universal Range - 1 Relay Output



	Model	UTR-1033	UTR-2033	UTR-433	UTR-413
Dimension (HxWxD)mm		96 x 96 x 43	72 x 72 x 45	48 x 48 x 70	48 x 48 x 70
Panel Cutout (mm)		92 x 92	68 x 68	45 x 45	45 x 45
INPUT	Start Pulse	Micro Switch / Limit Switch / Proximity (Configurable)			
	Range	999 / 99.9 / 9.99 Sec / Min / Hrs (Configurable)			
OUTPUT		1 Relay 2C/O 5A,230V AC (Resistive Load)			
Program		Delayed ON / Delayed OFF / Cycle Mode (Configurable)			
Count Direction		UP / Down (Configurable)			
Memory		YES / NO (Configurable)			
Reset		Front & Back Both Reset Available			
Supply		100 - 270V AC (SMPS), 50/60Hz			

Programmable Timer

Universal Timer - 2 Relay Output



	Model	UTR-1244	UTR-2244	UTR-4244	CTU-4244 (Universal Timer + Counter)
Dimension (HxWxD)mm		96 x 96 x 54	72 x 72 x 45	48 x 48 x 70	48 x 48 x 70
Panel Cutout (mm)		92 x 92	68 x 68	45 x 45	45 x 45
INPUT	Start Pulse	Micro Switch / Limit Switch / Proximity (Configurable)			
	Range	9999 / 999.9 / 99.99 Sec / Min / Hrs (Configurable)			
OUTPUT		2 Relay 1C/O 5A,230V AC (Resistive Load)			
Program		Forward - Reverse Mode, Cyclic Mode, Sequential Mode, Combination Mode (Configurable)			Timer: ON Delay, Interval, Cyclic On first, Batch Counter: ON Delay, Interval, Cyclic On first, Batch Batch Available in 2nd Relay
Count Direction		UP / Down (Configurable)			
Memory		YES / NO (Configurable)			
Reset		Front & Back Terminal Reset Available			
Supply		100 - 270V AC (SMPS), 50/60Hz			

Programmable Timers

Time Totalizer



Model	DTT-1000	DTT-2000	DTT-3000	DTT-56G	DTT-5000
Dimension (HxWxD)mm	96 x 96 x 43	72 x 72 x 36	48 x 96 x 26	38 x 62 x 63	36 x 77 x 72
Panel Cutout (mm)	92 x 92	68 x 68	46 x 92	31 x 54	30 x 71
INPUT	Input	Micro Switch / Limit Switch / Proximity Switch / 230V AC (Factory Set)			
	Range	1) 9999.59 hr/min. 2) 9999.59 min/sec. 3) 99999.9 sec. 4) 999999 sec. 5) 9999.99 sec. 6) 99999.9 min. 7) 999999 min. 99999.9 hr. 9) 999999 hr (Configurable)			
Supply	230V AC ±20%, 50Hz				

Digital Presettable Timer

Multi Range - Thumbwheel Setting



Model	MDT-1310F	MDT-2312F	MDT-4310N	DIN-63	DIN-63C
Dimension (HxWxD)mm	96 x 96 x 50	72 x 72 x 45	48 x 48 x 70	76 x 28 x 85	76 x 28 x 85
Panel Cutout (mm)	92 x 92	68 x 68	45 x 45	Din Rail Mounting	Din Rail Mounting
INPUT	Range 999, 99.9, 9.99 Hour / Min / Sec (Configurable)				
OUTPUT	1 Relay 2C/O 5A, 230V AC (Resistive Load)		1 Relay 1C/O 5A, 230V AC (Resist. Load)	1 Relay 2C/O 5A, 230V AC (Resistive Load)	
Operating Mode	Delayed ON / Delayed OFF (Configurable)				Cycle ON / Cycle OFF
Counting Direction	UP / Down (Configurable)				
Memory	YES / NO (Configurable)				YES / NO (Configurable)
Supply	230V AC ±20%, 50Hz	100 - 270V AC (SMPS), 50/60Hz			

Programmable Counters

Photo Electric Controllers

For Fully Pneumatic Packaging Machine

Model	PFLC-68	
Dimension (HxWxD)mm	96 x 96 x 54	
Panel Cutout (mm)	92 x 92	
INPUT	Input 1	Start Pulse
	Input 2	Color Mark Sensor (NPN/PNP Selection)
	Input 3	Unwinding Start
	Input 4	Unwinding Stop
OUTPUT	Output 1	Clutch & Brake, 24V DC 2A
	Output 2	H - Sealer Relay
	Output 3	V - Sealer Relay
	Output 4	Nitrogen Filling Relay
	Output 5	Batch Cutter Relay
	Output 6	Batch Coding Relay
	Output 7	Auger Relay
	Output 8	Unwinding Relay
Memory	Non - Volatile Memory	
Reset	Manual Reset	
Supply	24V DC	



**Touch
Screen**



Model	MPC-1065	
Dimension (HxWxD)mm	96 x 96 x 50	
Panel Cutout (mm)	92 x 92	
INPUT	Input 1	2 NPN/PNP Proximity Switch (Factory Set)
	Input 2	Color Mark Sensor (NPN/PNP Selection)
OUTPUT	Output 1	Clutch & Brake
	Output 2	H - Sealer Relay
	Output 3	Nitrogen Filling Relay
	Output 4	Batch Cutter Relay
	Output 5	Unwinding Relay
Memory	Non - Volatile Memory	
Reset	Manual Reset	
Supply	24V DC	

Programmable Counters

Photo Electric Controllers



Model	MPC-1061L / MPC-1062L	MVC-72N	MVC-7210
Dimension (HxWxD)mm	96 x 96 x 50	72 x 72 x 45	72 x 72 x 97
Panel Cutout (mm)	92 x 92	68 x 68	68 x 68
DISPLAY	Graphical LCD		
INPUT	Input 1: 1 or 2 NPN Proximity Switch (Factory Set) Input 2: Color Mark Sensor	NPN / PNP Proximity Switch	NPN / PNP Proximity Switch
OUTPUT	2 Output (Forward & Reverse Winding), 2A, 110V AC / 230V AC + Buzzer Output	0 - 110V AC Corresponding to percentage input	0 - 110V AC Corresponding to percentage input
Memory	Non - Volatile Memory		
Reset	Manual Reset		
Supply	For MPC-1061L 110V AC, ±20%, 50Hz For MPC-1021L 230V AC, ±20%, 50Hz	230V AC ±20%, 50Hz	230V AC ±20%, 50Hz
Note		Vibrator load should not be more than 5Amps (Resistive Load) Range : 1 to 99%	Vibrator load should not be more than 10Amps (Resistive Load) Range : 1 to 99%

Clutch Brake Controller

For Packaging Machine Application



Model	MC-1003	MMC-1046T
Dimension (HxWxD)mm	96 x 96 x 50	96 x 96 x 54
Panel Cutout (mm)	92 x 92	92 x 92
INPUT	Input 1: NPN Proxy for Clutch Input 2: NPN Color mark Sensor (CMS) Input 3: Micro Switch Range: Clutch ON Time : 0 - 99.99 Sec. Batch Time : 0 - 99.99 Sec.	0 - 99.99 Sec.
OUTPUT	Output 1: For Clutch Output 2: For Inching Output 3: For Batch Counter	For Clutch
Reset	Front Reset	
Supply	100 - 270V AC (SMPS), 50/60Hz	

16 X 2 LCD Display

Programmable Counters

Color Mark Sensor

For Packaging Machine & Printing Industries

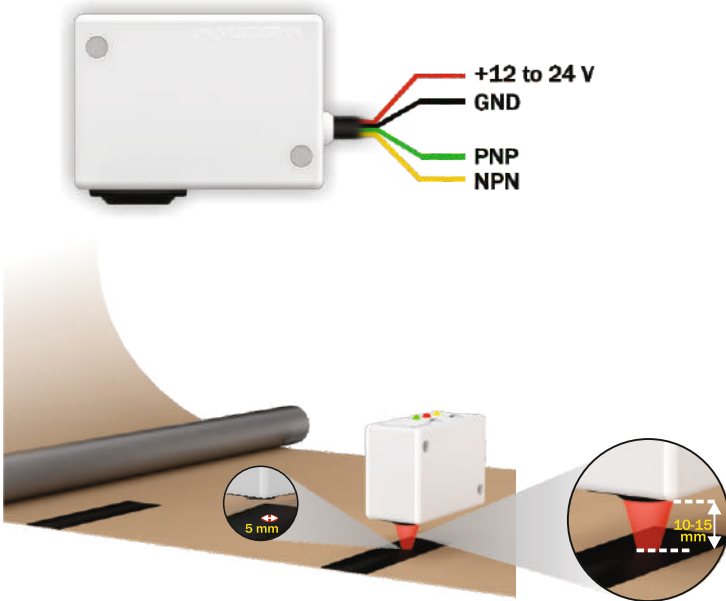

Model	CMS-5X
Power Supply	12 - 24V DC
Current Consumption	35mA max.@ 24V DC
Output	NPN / PNP Output
Output Current	25mA max
Response Time	2 Millisecond
Indications	LED 1 : Mark LED (Green) LED 2 : Output LED (Red) LED 3 : Background LED (Yellow)
Push Buttons	Button 1 : Mark Button Button 2 : Background Button
Minimum Mark Output Relay	20ms
Operating Temperature	-10 to 50C
Storage Temperature	-20 to 70C
Operating Distance	10mm - 15mm
Minimum Spot Diameter	5mm
Emission type	RED (630nm) GREEN (520nm) BLUE (465nm)
Ambient Light Rejection	Yes
Vibration	0.5mm Amplitude, 10 to 55 Hz Frequency
Housing Material	ABS
Lens Material	Glass
Connection	Shielded 4 Wire Cable

Programmable Counters

Digital Batch Counter



Model	BC-1046D	BC-2046	BC-445
Dimension (HxWxD)mm	96 x 96 x 43	72 x 72 x 45	48 x 48 x 95
Panel Cutout (mm)	92 x 92	68 x 68	45 x 45
INPUT	Input	NPN/PNP Proximity Switch / Micro Switch (Configurable) or 230V AC Pulse (Factory Set)	
	Range	Upper Display Range : 0-999999 Count Lower Display Range : 0-9999	Upper Display Range : 0-99999 Count Lower Display Range : 0-9999
OUTPUT	1 Relay + Buzzer		
	Non - Volatile Memory		
Reset	Auto Reset / Manual Reset / Back Reset		
Supply	230V AC \pm 20%, 50Hz	100 - 270V AC (SMPS), 50/60Hz	

Digital Length Counter

With Proximity / Single & Dual Channel Encoder Input



Model	LC-1046D	LC-2046	LC-3006	LC-445
Dimension (HxWxD)mm	96 x 96 x 43	72 x 72 x 45	48 x 96 x 120	48 x 48 x 95
Panel Cutout (mm)	92 x 92	68 x 68	46 x 92	45 x 45
INPUT	Input	NPN/PNP Proximity Switch (Configurable) or Encoder (Factory Set)		
	Range	0-99999.9 / 0-999999 / 0-9999.99 / 0-999.999 Meter (Configurable)		0-9999.9 / 0-99999 / 0-999.99 Meter (Configurable)
OUTPUT	1 Relay 1C/O, 5A @230V AC (Resistive Load)			
MPM Range	999.9 MPM			
Diameter	0-9999.99 MM			
Memory	Non - Volatile Memory			
Reset	Auto Reset / Manual reset facility & front and back reset			
Supply	230V AC, \pm 20% 50Hz	100 - 270V AC (SMPS), 50/60Hz	230V AC, \pm 20% 50Hz	100 - 270V AC (SMPS), 50/60Hz
Note	In LC-445 if back reset option is required, then input would be proximity sensor (NPN or PNP) (Factory Set) RS-485 Modbus Communication is available as per request in 96x96 Size (LC-1048-M1) 2 Relay Output available as per request in 72x72 size (MMC-2046) , 96x96 size MMC-1000			

Programmable Counters

Digital Programmable Counter



Model	PC-1044	PC-2044	PC-444
Dimension (HxWxD)mm	96 x 96 x 54	72 x 72 x 45	48 x 48 x 70
Panel Cutout (mm)	92 x 92	68 x 68	45 x 45
INPUT	NPN/PNP Proximity Switch / Micro Switch (Configurable) or 230V AC Pulse or Encoder (Factory Set)		
Input			
Range	0 - 9999 Count		
OUTPUT	1 Relay 1C/O 5A,230V AC (Resistive Load)		
Count Direction	UP / Down (Configurable)		
Memory	YES / NO (Configurable)		
Reset	Auto Reset / Manual Reset / Reset at back		
Supply	230V AC \pm 20%,50Hz	100 - 270V AC (SMPS), 50/60Hz	
Note	Dual Set Point , Scale factor & 2 Relay Option Available on customer request in PC-1044,2044		

Digital Presetable Counter With Thumbwheel Setting



Model	TWS-1400F	TWS-2500F
Dimension (HxWxD)mm	96 x 96 x 50	72 x 72 x 45
Panel Cutout (mm)	92 x 92	68 x 68
INPUT	NPN/PNP Proximity Switch / Micro Switch (Configurable) or 230V AC Pulse or Encoder (Factory Set)	
Input		
Range	0 to 9999	
OUTPUT	1 Relay 2C/O 5A,230V AC (Resistive Load)	
Operating Mode	Delayed ON / Delayed OFF (Configurable)	
Count Direction	UP / Down (Configurable)	
Memory	YES / NO (Configurable)	
Speed Selection	Medium (UP to 5000 rpm) , Fast (UP to 15000 rpm) (Configurable)	
Supply	100 - 270V AC (SMPS), 50/60Hz	

Programmable Counters

Digital RPM Indicator



Model	RPM-1201	RPM-2201	RPM-3201	RPM-4201
Dimension (HxWxD)mm	96 x 96 x 40	72 x 72 x 36	48 x 96 x 26	48 x 48 x 70
Panel Cutout (mm)	92 x 92	68 x 68	46 x 92	45 x 45
INPUT	Input	NPN/PNP Proximity Switch (Configurable)		
	Range	4 - 5000 RPM		
Supply	230V AC ±20%, 50Hz	100 - 270V AC (SMPS), 50/60Hz		

Digital Count Totalizer



Model	CT-1000	CT-2000	CT-3000	CT-5000	CT-56G
Dimension (HxWxD)mm	96 x 96 x 40	72 x 72 x 36	48 x 96 x 26	36 x 72 x 93	38 x 62 x 63
Panel Cutout (mm)	92 x 92	68 x 68	46 x 92	32 x 68	31 x 54
INPUT	Input	NPN/PNP Proximity Switch / Micro Switch (Configurable) or 230V AC Pulse or Encoder (Any one factory set)			
	Range	0 to 999999 Count			
Memory	Non - Volatile Memory				
Reset	Manual reset, Back reset (Optional)				
Supply	230V AC ±20%, 50Hz	100 - 270V AC (SMPS), 50/60Hz	230V AC ±20%, 50Hz		

Programmable Counters

Speed / Ratio Indicator



Model	MPM-1044 / MPM-2044	RPM-1044 / RPM-2044
Dimension (HxWxD)mm	96 x 96 x 54 / 72 x 72 x 85	96 x 96 x 54 / 72 x 72 x 85
Panel Cutout (mm)	92 x 92 / 68 x 68	92 x 92 / 68 x 68
INPUT	NPN/PNP Proximity Switch (Configurable), Proximity Input (Stretch Ratio Indicator)	
Range	0 to 9999 or 0 to 999.9 MPM (Factory set), 0 to 9999 RPM	
OUTPUT	1 Relay on RPM/MPM (Factory Set) & Retransmission Output (4-20mA DC / 0-10V DC) (Factory Set) (Optional)	
Diameter Range	0 to 999.9 MM (Only for MPM / Stretch Ratio MPM)	
Accuracy	±1% of FSD	
Supply	100 - 270V AC (SMPS), 50/60Hz	

Programmable Timer

Counter + RPM



Model	MMC-1046RD	MMC-2046R
Dimension (HxWxD)mm	96 x 96 x 43	72 x 72 x 45
Panel Cutout (mm)	92 x 92	68 x 68
INPUT	NPN/PNP Proximity Switch / Micro Switch (Configurable) / 230V AC Pulse (Factory Set)	
Range	Upper Display Range : 0 - 999999 Count, Lower Display Range : 0 - 9999 RPM	
OUTPUT	1 Relay 1C/O 5A, 230V AC (Resistive Load)	
Memory	Non - Volatile Memory	
Reset	Auto Reset / Manual Reset / Back Reset	
Supply	230V AC ±20%, 50Hz	100 - 270V AC (SMPS), 50/60Hz

Protection Relays

Automatic Power Factor Controller

Intelligent PF Correction Relay



Graphical LCD Display

6 / 8 / 12 / 14 / 16 Steps

Model	APFC 96-L6	APFC 9606	APFC 108	APFC 112
Dimension (HxWxD)mm	96 x 96 x 54	96 x 96 x 54	144 x 144 x 70	144 x 144 x 70
Panel Cutout mm	92 x 92	92 x 92	137 x 137	137 x 137
INPUT	Current 50mA to 5Amp AC (Without CT) (CT Ratio Selectable 5/5A to 9995/5A) For Main CT & Capacitor CT Controlling PF Range +0.80 (Lag) To -0.80 (Lead) Min. Operation Current 1% to 10% of Primary CT in PF & KVAR Mode (User Select.) Factory Set 3% of Primary CT in all Controlling Mode Input Volatge 30 to 290V AC (P-N) CAT III		Current 0.01 to 5Amp AC (Without CT) (CT Ratio Selectable 5/5A AC to 9999/5A) For Main CT & Capacitor CT Controlling PF Range +1.000 (Lag) To -1.000 (Lead) Min. Operation Current Selectable Range 1mA to 500mA (By Default 30mA)	
SENSING	Single CT Based Sensing True RMS, Scan Time 1Sec. to 999 Sec.		Scan Time 1 Sec. to 999.9 Sec.	
OUTPUT	NO-C 6 Relay for Capacitor Bank		NO-C 8 Relay for capacitor bank + 1 Alarm or 1 Fan Relay	NO-C 12 Relay for capacitor bank + 1 Alarm Relay 1 Fan Relay
USER PROGRAMM. FUNCTIONS	Set PF, Relay Switch ON Time, Control Modes, Mains Primary CT Ratio, Relay Steps to be used, Capacitor Primary CT Ratio (To be used if actual capacitor value is to be measured at any given time)		Main CT Ratio, Capacitor CT Ratio, Minimum Operating Current, Scan Time, Programmable KVAR Hysteresis, Capacitor bank sensing method	
Control Mode	Auto Manual, KVAR (Set capacitor bank value), Rotational		KVAR/ Intel/ Manual	
Accuracy	Class 1.0 as per IEC 62053-22		Class 0.5	
Supply	230V AC ±20% Supply, 50Hz		300 to 520V AC (P-P) CAT III	

Protection Relays

Earth Leakage Relay



Model	ELR-19N	ELR-63	EFR-63
Dimension (HxWxD)mm	96 x 96 x 54	76 x 28 x 85	76 x 28 x 85
Panel Cutout mm	92 x 92	Din Rail Mounting	Din Rail Mounting
INPUT Input Signal	30mA to 3Amp AC Thru. External CBCT	30mA to 3.00A AC Thru. External CBCT	Current : 5Amp From CBCT
Range	30mA to 3.00A AC	30mA to 3.00A AC	
OUTPUT	1 Relay (NO-C-NC) 5A, 230V AC Resistive Load	1 Relay (NO-C) 5A, 230V AC Resistive Load	1 Relay (5A, 230V AC Resistive Load) Earth Fault Current
Accuracy	Class 0.5	Class 0.5	Class 0.5
Supply	100 to 270V AC (SMPS), 50/60Hz	100 to 270V AC (SMPS), 50/60Hz	100 to 270V AC (SMPS), 50/60Hz
Note	RS-485 Modbus is available in ELR-19N as per request, CBCT available as per required inner diameter		

Current Controller



Model	CC-12
Dimension (HxWxD)mm	96 x 96 x 43
Panel Cutout mm	92 x 92
INPUT Current	5A AC Direct (CT Ratio Selectable 5/5A to 1600/5A)
OUTPUT	1 Relay (NO-C-NC) 5A, 230V AC (Resistive Load)
Tripping Facility	High/ Low/ Inband/ Outband/ Absolute Low/ Absolute Outband Alarm (Configurable)
Accuracy	Class 0.5
Power Supply	100 to 270V AC (SMPS), 50/60Hz, Approx 4VA
Note	RS-485 Modbus is available on request 2 Relay is available on request in CC-122

Earth To Neutral Voltage



Model	EN-19N
Dimension (HxWxD)mm	96 x 96 x 54
Panel Cutout mm	92 x 92
INPUT Voltage	0 to 10 Voltage AC
OUTPUT	1 Relay (NO-C-NC) 5A, 230V AC (Resistive Load)
Parameter	Earth to Neutral Voltage Protection Relay
Power Supply	100 to 270V AC (SMPS), 50/60Hz
Note	RS-485 Modbus available

Protection Relays

Protection Device - 3 Phase



DINRAIL MOUNT

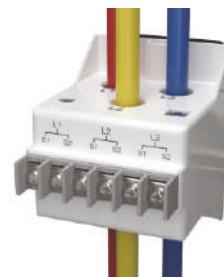

Model	MPD-192		MPD-152	
Dimension (HxWxD)mm	96 x 96 x 54		75 x 55 x 110	
Panel Cutout mm	92 x 92		Din Rail Mounting	
INPUT	Signal	3Ø4 Wire / 3Ø3 Wire		
	Voltage	50 - 520V AC (L-L), 30 - 300V AC (L-N)		
	Current	60mA to 5A (CT Selection 5A - 6000A AC) (Additional Leakage Current Measurement thru CBCT in MPD-19EL)		
OUTPUT	1st Relay (NO-C-NC) 10A, 230V AC (Resistive Load) 2nd Relay (NO-C) 5A (With Simultaneous Actuation)		1 Relay (NO-C-NC) 10A, 230V AC (Resistive Load)	
PARAMETER	Over Current	Under Current	Short Circuit	Lock Rotor Point
	Over Voltage	Under Voltage	Phase Sequence	Unbalance
	Over Frequency	Under Frequency	Phase Loss	Neutral Loss
				Earth Leakage (in MPD-19EL)
Accuracy	Class 0.5			
Supply	100 to 270V AC (SMPS), 50/60Hz			
Note	MPD-192 is also available in 50 to 550V AC, 50Hz Power Supply (ON Request), RS-485 Modbus Communication (Optional) in MPD-19EL-M1. Earth Leakage Features are Available (Optional) in MPD-19EL, CBCT Available As per Required inner Diameter. External CT 30A, 60A, 100A, 125A Available As per Request.			

Voltage Monitoring Relay



Model	VMR-13		VMR-232	
Dimension (HxWxD)mm	96 x 96 x 43		72 x 72 x 45	
Panel Cutout mm	92 x 92		68 x 68	
INPUT	Voltage	50 to 520V AC (L-L), 30 to 300V AC (L-N)		
OUTPUT	1st Relay 5A, 230V AC (Resistive Load) 2nd Relay (Optional)		1st Relay 10A, 230V AC (Resistive Load)	
PARAMETER	Over Voltage	Over Frequency	Phase Loss	Asymmetry
	Under Voltage	Under Frequency	Phase Sequence	Neutral Loss
Supply	230V AC ±20%, 50Hz		50 to 520V AC, 50/60Hz	

Protection Relays

Three Phase Voltage & Current Protection Relay

DINRAIL MOUNT



Model	VPR-126	VPR-3P	CPR-126 (3 Phase)	CPR-126-1C (1 Phase)
Dimension (HxWxD)mm	75 x 45 x 110	75 x 45 x 110	75 x 45 x 110	75 x 45 x 110
Mounting	Din Rail Mounting			
INPUT	Signal	3Ø4 Wire / 3Ø3 Wire / 1Ø2 Wire	3Ø4 Wire / 3Ø3 Wire	3Ø3 Wire
	Voltage	30 to 300V AC (L-N), 50 to 520V AC (L-L)	160 to 300V AC (L-N), 280 to 520V AC (L-L)	
	Current			0.5 to 5Amp (CT Selection 5/5 To 999/5 A AC)
OUTPUT	1st Relay (NO-C-NC) 2nd Relay (NO-C-NC) (Optional)	1st Relay (NO-C-NC) 2nd Relay (NO-C-NC)	1 Relay (NO-C-NC)	
PARAMETER	Over Voltage Under Voltage Over Frequency Under Frequency Phase Loss Phase Sequence Asymmetry & Neutral Loss	Over Voltage Under Voltage Over Frequency Under Frequency Phase Loss Phase Sequence Asymmetry	Over Current Under Current Asymmetry Single Phase Preventer (SPP)	Over Current Under Current
Accuracy	Class 1.0	Class 1.0	Class 1.0	Class 1.0
Supply	100 to 270V AC (SMPS)	No Power Supply to be given Separately	100 to 270V AC (SMPS)	100 to 270V AC (SMPS)
Note	External CT 30A,60A,100A Available with CPR-126 & CPR-126-1C As per Request			

Multi Channel Current Transducer

CT upto 100A

DINRAIL MOUNT

3CT

4CT

6CT



Model	MCS-63
Dimension (HxWxD)mm	76 x 28 x 116
Mounting	Din Rail Mounting
INPUT	Current : 2A to 60A Direct UP to 6 Current Scanner
OUTPUT	RS-485 Modbus
POWER SUPPLY	24V DC
Note	100 Amp 3 CT Also Available

Coming Soon....

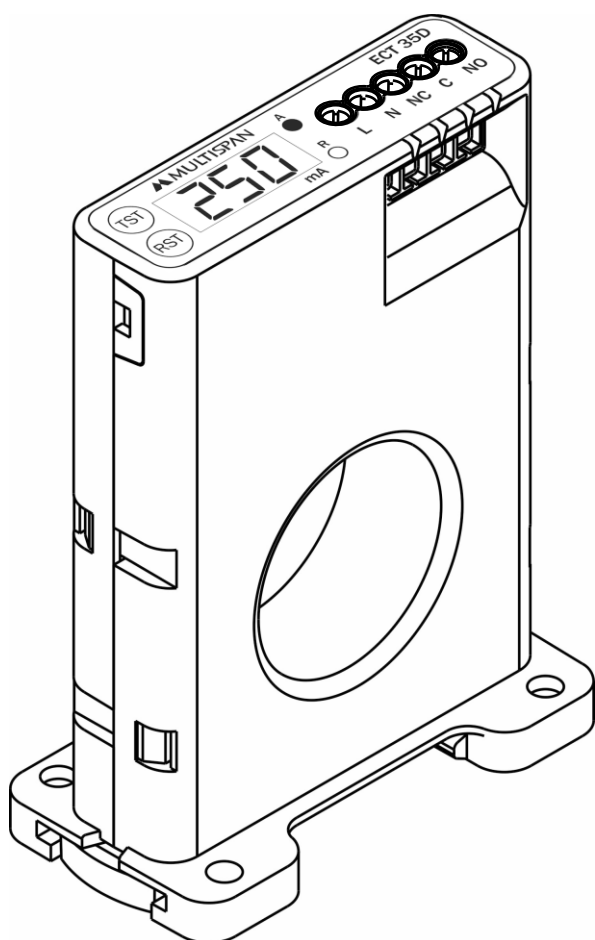

Earth Leakage Relay with Inbuilt CBCT

Voltage Protection Relay Compact Size

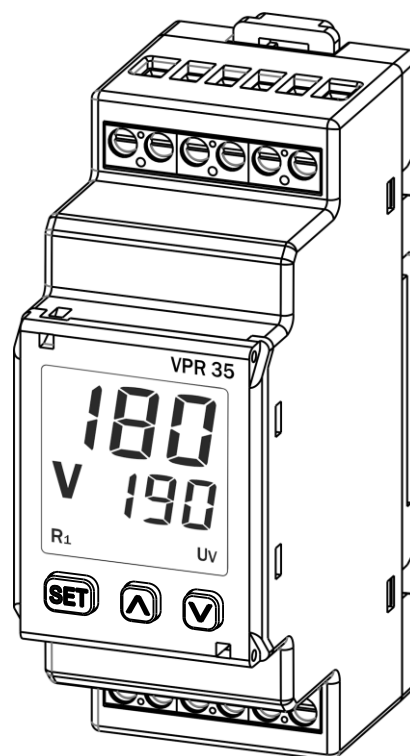

25A 40A 50A 70A **Solid State Relays**

Model	RS-40A
Dimension (HxWxD)mm	62 x 45 x 25
INPUT	4 - 32V DC / 4 - 16mA
OUTPUT	24 - 480V AC
FEATURES	Input LED Indication Zero Cross over SSR Design PIV : 800V



Switched Mode Power Supply



Model	PS24-5A
Dimension (HxWxD)mm	105 x 45 x 110
INPUT	100V - 270V AC
OUTPUT	24V DC, 5A
RATED POWER	120W
PROTECTION	Over Load, Over Voltage, Output Short Circuit, Over Temperature

Din Rail Protection Relays

Voltage & Current

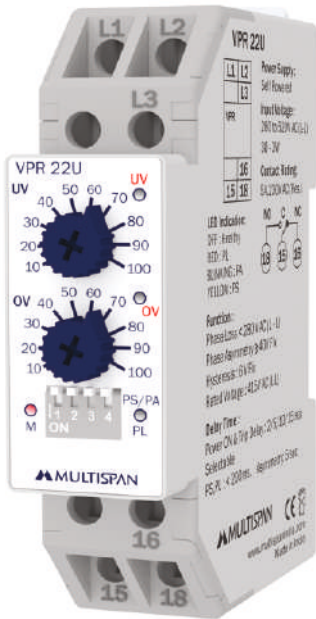

Model	VPR-220 Voltage Protection Relay
Dimension (HxWxD)mm	90 x 22.5 x 72
Mounting	Din Rail Mounting
INPUT	Input Voltage : 280 to 520V AC (L-L), 3Ø3 Wire
OUTPUT	1 Relay, 5A, 230V AC (Resistive Load)
TRIPPING PARAMETER	Under Voltage Over Voltage Phase Asymmetry Phase Sequence Phase Loss
POWER SUPPLY	NO Power Supply to be given separately
Note	Power ON Delay Time & Trip Delay Time by using DIP switch

Model	SPP-22 / V22-RYB Single Phase Preventor
Dimension (HxWxD)mm	90 x 22.5 x 66.5 / 90 x 22.5 x 70.5
Mounting	Din Rail Mounting
INPUT	Input Voltage : 280 to 520V AC (L-L), 3Ø3 Wire
OUTPUT	1 Relay 5A, 230V AC (Resistive Load)
TRIPPING PARAMETER	Phase Asymmetry Phase Sequence Phase Loss
POWER SUPPLY	NO Power Supply to be given separately

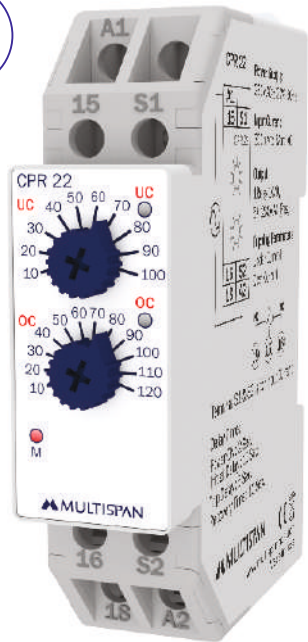
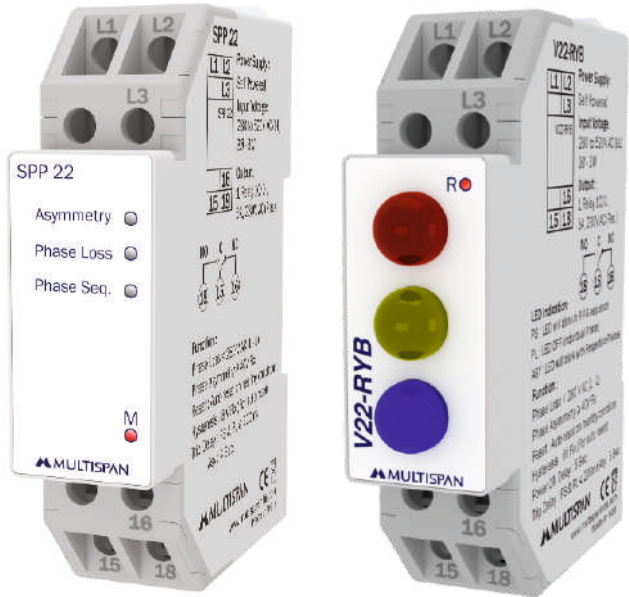

Model	CPR-22 Current Protection Relay
Dimension (HxWxD)mm	90 x 22.5 x 72
Mounting	Din Rail Mounting
INPUT	Input Current : 300mA to 5A AC
OUTPUT	1 Relay 5A, 230V AC (Resistive Load)
TRIPPING PARAMETER	Under Current Over Current
POWER SUPPLY	230V AC ±20%, 50Hz

Din Rail Analog Timers

22 Timer Series



Model	DT Series
Dimension (HxWxD)mm	90 x 22.5 x 72
Mounting	Din Rail Mounting
INPUT Range	0 to 10 Sec (For DT-10S) 0 to 30 Sec (For DT-30S) 0 to 60 Sec (For DT-60S) 0 to 30 Min (For DT-30M)
OUTPUT	1 Relay 1C/O, 5A 230V AC (Resistive Load)
POWER SUPPLY	230V AC \pm 20%, 50Hz / 24V DC / 415V AC (Factory Set)

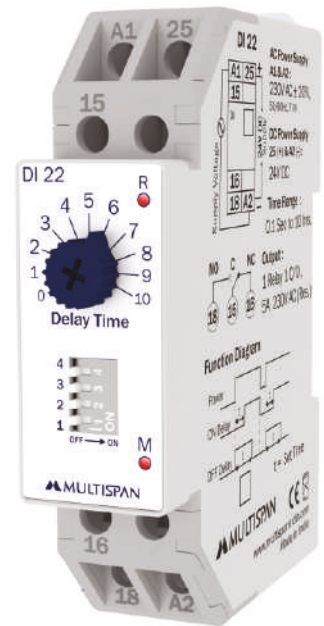

Model	DI-22
Dimension (HxWxD)mm	90 x 22.5 x 72
Mounting	Din Rail Mounting
INPUT Range	0.1 Sec to 10 Sec / Min / Hour
OUTPUT	1 Relay 1C/O 5A, 230V AC (Resistive Load)
POWER SUPPLY	230V AC \pm 20%, 50Hz & 24V AC/DC

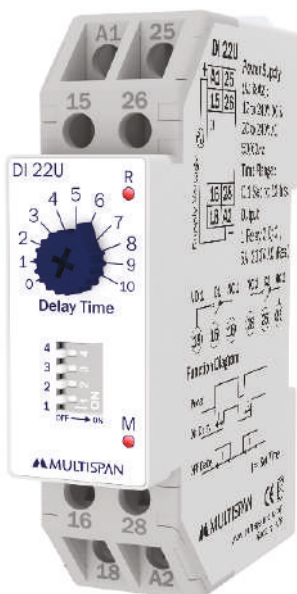

Model	DI-22U
Dimension (HxWxD)mm	90 x 22.5 x 72
Mounting	Din Rail Mounting
INPUT Range	0.1 Sec to 10 Sec / Min / Hour
OUTPUT	1 Relay 2C/O 5A, 230V AC (Resistive Load)
POWER SUPPLY	12V to 240V DC & 20V to 240V AC, 50/60Hz

Din Rail Analog Timers

22 Timer Series

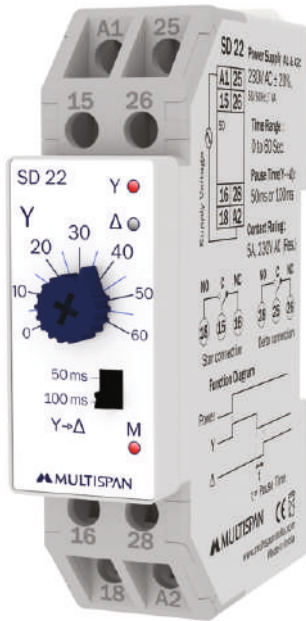

Model	SD-22 Star Delta Timer
Dimension (HxWxD)mm	90 x 22.5 x 72
Mounting	Din Rail Mounting
INPUT	Range Time Range : 0 to 60 Sec Pause Time : 50ms or 100ms Selection by front key
OUTPUT	2 Relay O/P (1C/O, 5A 230V AC (Resistive Load) 1st Relay for star connection & 2nd Relay for delta connection
POWER SUPPLY	230V AC $\pm 20\%$, 50Hz
Note	415V AC Supply Available on request (SD-224)

Model	CYL-22U Cycle Timer (Universal Supply)
Dimension (HxWxD)mm	90 x 22.5 x 72
Mounting	Din Rail Mounting
INPUT	Range 0.1 Sec to 10 Sec / Min / Hour
OUTPUT	1 Relay 2C/O 5A, 230V AC (Resistive Load)
POWER SUPPLY	12V to 240V DC & 20V to 240V AC, 50/60Hz

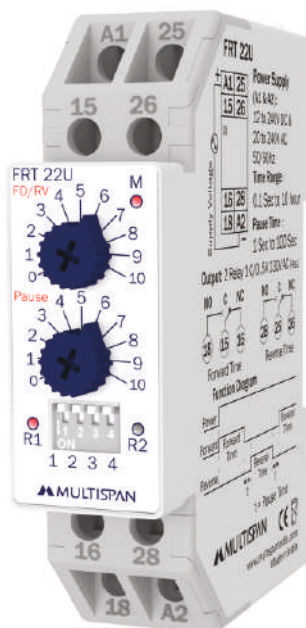
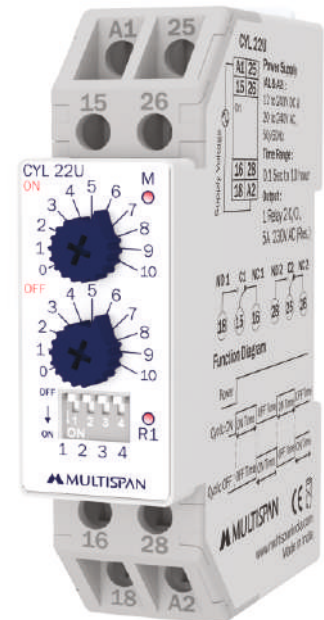

Model	FRT-22U Forward Reverse Timer (Universal Supply)
Dimension (HxWxD)mm	90 x 22.5 x 72
Mounting	Din Rail Mounting
INPUT	Range Forward & Reverse Time Range : 0.1 Sec to 10 Hour Pause Time : 1 Sec to 100 Sec
OUTPUT	2 Relay 1 C/O, 5A 230V AC (Resistive Load) 1st Relay For Forward Time & 2nd Relay For Reverse Time
POWER SUPPLY	12V to 240V DC & 20V to 240V AC, 50/60Hz

Power & Energy Meters

Multifunction Meter



Model	AVH-14	MFM-13
Dimension (HxWxD)mm	96 x 96 x 54	96 x 96 x 54
Panel Cutout mm	92 x 92	92 x 92
INPUT	Signal 3Ø4 Wire / 3Ø3 Wire / 1Ø2 Wire Voltage Primary : 100V to 520kv (Programmable), Secondary : 100V to 520V (L-L) (Programmable) Current Current : 5A to 6000A (Programmable), Secondary : 5A/1A (Programmable)	
PARAMETER	kW Total 0.000 - 9999 KW KW Per Phase 0.000 - 9999 KW WH Total 0.000 - 999999 MWH Power Factor Average (PF) 0.100 - 1.000 Power Factor Per Phase (PF) 0.100 - 1.000 KVA Total 0.000 - 9999 KVA VAH Total 0.000 - 999999 MVAH Frequency (Hz) 45 - 60Hz KVAr Total 0.000 - 9999 KVAr Varh Total 000.000 - 999999 MVArh Load Hours 9999.59 Hrs/Min. NO Load Hours 9999.59 Hrs/Min. RPM 3600 RPM @ 60Hz & 2 Pole	0.000 - 9999 MW 0.000 - 9999 MW 000.000 - 999999999.999 KWH 0.100 - 1.000 0.100 - 1.000 0.000 - 9999 MVA 000.000 - 999999999.999 KVAH 45 - 60Hz 0.000 - 9999 MVAr 000.000 - 999999999.999 KVArh 9999.59 Hrs/Min. 9999.59 Hrs/Min. 3600 RPM @ 60Hz & 2 Pole
COMMUNICATION	RS-485 Modbus (Optional) Pulse Output	
Accuracy	Class 0.5	
Supply	100 to 270V AC (SMPS) , 50/60Hz, Approx 4VA	

IIoT Solutions



RS-485 MODBUS RTU



Gateway

Energy Monitoring System Data Logging on Cloud

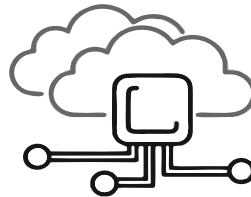

Cloud Storage

Web application

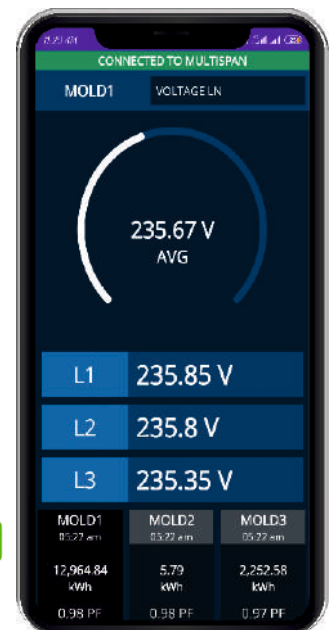

Visit for live Demo www.iiotmultispan.com

Power & Energy Meters

3 Phase Energy & Power Meter



	Model	EPM-14	EM-10	EM-1P
Dimension (HxWxD)mm		96 x 96 x 54	96 x 96 x 43	96 x 96 x 43
Panel Cutout mm		92 x 92	92 x 92	92 x 92
INPUT	Signal	3Ø4Wire		1Ø2 Wire
	Voltage	30 to 300V AC (L-N) / 50 to 520V AC (L-L)		30 to 300V AC (L-N)
	Current	5/5 to 9999A AC CT Ratio Selectable		5/5 to 9999A AC
Measuring Range	Reset	KWH Reset by front key	By front keypad	Reset by front key
		0.000 to 9999 KW (Active Power) 0 to 99999999 KWH (Active Energy)	0 to 99999999 KWH (Active Energy)	0 to 99999999 KWH (Active Energy)
Accuracy		Class 1.0		
Supply		100 to 270V AC (SMPS),50/60Hz		
Note		RS-485 Modbus available, 2 Relay available in only EPM-14 As per request		

3 Phase and 1 Phase Panel Meter

VAF METER



	Model	AVF-29T	AVF-19D	AVF-133
Dimension (HxWxD)mm		72 x 72 x 45	96 x 96 x 43	96 x 96 x 54
Panel Cutout mm		68 x 68	92 x 92	92 x 92
INPUT	Signal	3Ø4Wire / 3Ø3 Wire / 1Ø2 Wire		3Ø4Wire / 3Ø3 Wire / 1Ø2 Wire
	Voltage	Primary PT : 100V to 520KV Secondary PT : 50 to 520V AC (L-L)	30 to 300V AC (L-N) 50 to 520V AC (L-L)	30 to 300V AC (L-N) 50 to 520V AC (L-L)
	Current	Primary CT : 9999A Secondary CT : 5A/1A	Primary CT : 9999A Secondary CT : 5A	Primary CT : 9999A Secondary CT : 5A
PARAMETER		Voltage (L-L) Voltage (L-N) Average Current (L1,L2 & L3) Line Current (L1,L2 & L3) Phase Sequence	Average Voltage (L-N) Average Voltage (L-L) Frequency Load Hour / No Load Hour RPM	Voltage (L-L) Voltage (L-N) Average Current (L1,L2 & L3) Line Current (L1,L2 & L3) Phase Sequence
				Average Voltage (L-N) Average Voltage (L-L) Frequency Load Hour RPM
Accuracy		Class 0.5		Class 0.5
Supply		100 to 270V AC (SMPS),50/60Hz		230V AC ±20%,50Hz
Note		RS-485 Modbus Available in AVF-133 as per request		

Power & Energy Meters

3 Phase Ampere Meter



Model	AMP-19	AMP-13	AMP-23
Dimension (HxWxD)mm	96 x 96 x 43	96 x 96 x 43	72 x 72 x 45
Panel Cutout mm	92 x 92	92 x 92	68 x 68
INPUT	Current	Current	Current
	0.5A to 5A Primary : 5A to 9999A AC CT Selection Secondary : 5A	0.5A to 5A Primary : 5 to 10K Ampere (Selectable) Secondary : 1A/5A (Selectable)	0.5A to 5A Primary : 5A to 9999A AC CT Selection Secondary : 1A/5A (Selectable)
Accuracy	Class 0.5	Class 0.5	Class 0.5
Supply	230V AC $\pm 20\%$, 50Hz	100 to 270V AC (SMPS), 50/60Hz	100 to 270V AC (SMPS), 50/60Hz
Note	RS-485 Modbus is available in AMP-13		

3 PHASE VOLT METER



Model	VOLT-19	VOLT-13	VOLT-23
Dimension (HxWxD)mm	96 x 96 x 43	96 x 96 x 43	72 x 72 x 36
Panel Cutout mm	92 x 92	92 x 92	68 x 68
INPUT	Voltage	Voltage	Voltage
	50 to 520V AC (L-L) Primary : 100 to 999KV (L-L) (Selectable) Secondary : 100 to 520V AC (L-L) (Selectable)		
Accuracy	Class 0.5	Class 0.5	Class 0.5
Supply	100 to 270V AC (SMPS), 50/60Hz	230V AC $\pm 20\%$, 50Hz	100 to 270V AC (SMPS), 50/60Hz

Power & Energy Meters

Single Phase AC Panel Meter

VOLT / AMP METER



Model	AV-14/11V	AV-24/21V	AV-34/31V	AV-41CT/41A/41V
Dimension (HxWxD)mm	96 x 96 x 40	72 x 72 x 36	48 x 96 x 26	48 x 48 x 46
Panel Cutout mm	92 x 92	68 x 68	46 x 92	45 x 45
INPUT	Ampere (AC)	5A AC Direct		
	CT Ratio	Primary : 5/5A to 4000/5A AC		Primary : 5/5A to 2000/5A AC
	Voltage (AC)	10 to 500V AC		
Accuracy	Class 0.5			
Supply	230V AC \pm 20%,50Hz			
Note	30A Direct CT Available at back side (AV-11A, AV-21A, AV-31A, AV-41A)			

Single Phase AC Panel Meter

VOLT + AMP METER



Model	AV-12	AV-22	AV-33	AV-44	
Dimension (HxWxD)mm	96 x 96 x 43	72 x 72 x 60	48 x 96 x 66	48 x 48 x 66	
Panel Cutout mm	92 x 92	68 x 68	46 x 92	45 x 45	
INPUT	Current	Primary : 5/5A to 2000/5A AC			30.0A AC Direct
	Voltage	10 to 500V AC			30 to 500V AC
Accuracy	Class 0.5			Class 0.5	
Supply	230V AC \pm 20%,50Hz			100 to 270V AC, 50/60Hz	
Note	30A Direct CT Available at back side				

Power & Energy Meters

DC Panel Meter

VOLT / AMP METER



Model	AV-14DA/14DV	AV-24DA/24DV	AV-34DA/34DV	AV-41DV
Dimension (HxWxD)mm	96 x 96 x 40	72 x 72 x 60	48 x 96 x 66	48 x 48 x 70
Panel Cutout mm	92 x 92	68 x 68	46 x 92	45 x 45
INPUT	Ampere (DC)	0 to 9999 Ampere DC Through 75mV & 50mV DC External Shunt		
	Voltage (DC)	19.99V DC / 49.99V DC / 99.99V DC / 199.9V DC / 750V DC (Factory Set)		
Accuracy	±1% of Full Range 1± Count			
Supply	230V AC ±20%, 50Hz			
Note	0 to 2A DC / 5A DC / 10A DC / 20A DC Direct Through Shunt is Available in Model AV-14DZ, 24DZ, 34DZ			

SINGLE PHASE AC PANEL METER



Model	PF-11/PF-13	WM-11	FRQ-11
Dimension (HxWxD)mm	96 x 96 x 54	96 x 96 x 43	96 x 96 x 40
Panel Cutout mm	92 x 92	92 x 92	92 x 92
INPUT	Signal	1Ø2 Wire / 3Ø4 Wire	1Ø2 Wire
	Voltage	20 to 300V / 50 to 520V	300V AC (L-N)
Current	5A AC	0.5 to 5Amp (CT Selection 5 - 50A)	
CT Selection		5A	
Secondary Function			
Measuring Range		0 to 15 Kilo Watt	50.0Hz
Accuracy	Class 0.5	Class 0.5	Class 0.5
Supply	100 to 270V AC (SMPS), 50/60Hz	230V AC ±20%, 50Hz	230V AC ±20%, 50Hz
Note		Also Available in 199.9 Watt Range 1 Relay on KW is Available in WM-11	

Power & Energy Meters

DC Panel Meter

VOLT / AMP METER



Model	MFM-14DC	VAW-34DC
Dimension (HxWxD)mm	96 x 96 x 54	48 x 96 x 26
Panel Cutout mm	92 x 92	46 x 92
INPUT	Ampere (DC)	0 to 9999A DC Through -75mV to 75mV DC External Shunt
	Voltage (DC)	0 to 1000V DC
	Watt (DC)	0000 to 9999 KW DC
	Kwh	0 to 999999
Accuracy	±1% of Full Range ±1 Count	
Power Supply	100 to 270V AC (SMPS), 50/60Hz	
Note	RS-485 Modbus & 2 Relay available on request (In MFM-14DC-M1)	



Model	DC-14	DC-24
Dimension (HxWxD)mm	96 x 96 x 54	72 x 72 x 45
Panel Cutout mm	92 x 92	68 x 68
INPUT	Ampere (DC)	0 to 9999A DC Through -75mV to 75mV DC External Shunt
	Voltage (DC)	0 to 1000V DC
	Watt (DC)	0000 to 9999 KWh DC
Accuracy	±1% of Full Range ±1 Count	
Power Supply	100 to 270V AC (SMPS), 50/60Hz	

Jumbo Displays

Jumbo Display Indicators

Single & Double Side



8" Display

4" Display

Model	PTC-8004 (Single Side)	PIC-6004A / UTI-6004 / MPM-6004
Dimension (HxWxD)mm	325 x 650 x 50	Dual Side : 165 x 392 x 75, Single Side: 165 x 392 x 55
INPUT	Input	0 - 10V DC / 4 - 20mA DC / 0 - 20mA DC (Configurable), Pulse through encoder / Proximity (Factory set) J / K / PT-100 2 Wire 3 Wire (Configurable), Rs-485 Modbus (Master Slave Selectable)
	Range	J (0° to 400°C), K (0° to 1200°C), PT-100 2Wire or 3 Wire (-99.9° to 400.0°C) (-999 to 9999, 0 to 9999 Count For Analog Input)
OUTPUT	Output1	2 Relay For Alarm Output (Optional)
	Output2	24@30mA DC Transmitter Supply For analog Input (Optional)
Accuracy	±1% of FSD	
Power Supply	100 to 270V AC (SMPS), 50/60Hz / 24V DC (Factory Set)	
Note	1) For Analog Input Model : PIC-6004A / PIC-3004A / PTC-8004 2) For Proximity Input Model : PC-6004 / MPM-6004 / RPM-6004 / MSI-3004 / UTR-6004 3) For Temperature Input Model : UTI-3004 / UTI-6004	

PROGRAMMABLE JUMBO DISPLAY COUNTER

4" Display



Model	PC-6006 (Single Side)	
Dimension (HxWxD)mm	165 x 577 x 55	
DISPLAY	Single Display : 7 Segment, 6 Digit, 4" Red Led Display	
INPUT	Start Pulse	NPN / PNP Proximity Switch & Micro Switch (Configurable)
	Range	0 - 999999 Count
OUTPUT	1 Relay 1C/0 5A, 230V AC (Resistive Load) or SSR Drive O/P 12V DC, 20mA (Optional)	
Memory	Non - Volatile Memory	
Reset	Auto / Manual Reset / Back Reset	
Supply	100 to 270V AC (SMPS), 50/60Hz	
Note	RS-485 Input Available as per request (Master Slave Selectable)	

Jumbo Displays

Humidity + Temperature Controller

2.25" Display

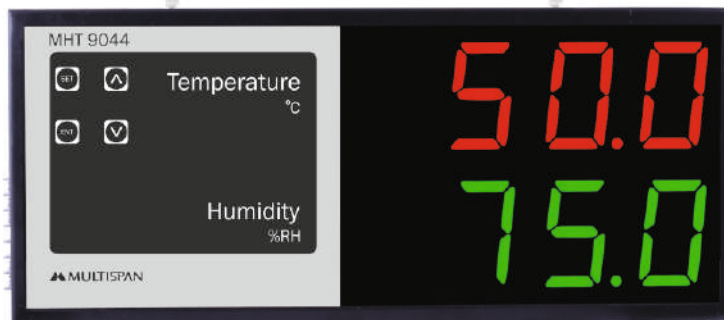

Model	MHT-9044 (Humidity + Temperature Controller)	
Dimension (HxWxD)mm	165 x 392 x 55	
DISPLAY	Upper Display : 7 Segment, 4 Digit, 2.25" Red Led Display - Temperature Lower Display : 7 Segment, 4 Digit, 2.25" Green Led Display - Humidity	
INPUT	Sensor	S-1 : PT-100 2 Wire or 3 Wire (RTD) S-2 : Humidity Sensor
	Range	PT-100 2 Wire or 3 Wire (-99 °C to 400 °C), Humidity Sensor (0.0 to 100.0% RH)
OUTPUT	1 st Relay For Temperature and 2 nd Relay For Humidity	
	Control Action	ON-OFF
	Accuracy	±1% of FSD
	Power Supply	100 to 250V AC (SMPS), 50/60Hz

PROGRAMMABLE JUMBO LENGTH COUNTER

2.25" Display



Model	LC-9004	
Dimension (HxWxD)mm	165 x 392 x 55	
DISPLAY	Upper Display : 7 Segment, 6 Digit, 2.25" Red Led Display - Total Meters Lower Display : 7 Segment, 4 Digit, 2.25" Green Led Display - Meter Per Minute	
INPUT	Start Pulse	NPN / PNP Proximity Switch / Micro Switch (Configurable) or Encoder (Factory Set)
	Range	0 - 99999.9 / 0 - 999999 Meter (Configurable)
OUTPUT	1 Relay 1C/0 5A,230V AC (Resistive Load) or SSR 12V max 20mA DC Output (Any One Factory Set)	
	MPM Range	999.9 MPM
	Diameter	0 - 9999.99 MM
	Memory	Non - Volatile Memory
	Reset	Auto Reset / Manual Reset Facility & Front and Back Reset Facility
	Supply	100 to 270V AC (SMPS), 50/60Hz
	Note	RS-485 Input / Output Available as per request

Jumbo Display Model Selection Guide

Sr. No	Product Model	Display Digit	Input	Display Parameter
1	PIC-6004A	4	4-20mA/0-10V/0-20mA DC	Process Value (-999 to 9999)
2	UTI-6004	4	J / K / PT-100	Temperature
3	PTC-6004	4	4-20mA/0-10V/0-20mA DC/ J / K / PT-100	Process Value (-999 to 9999)/ Temperature
4	PC-6004	4	NPN / PNP Proximity	Count
5	RPM-6004	4	NPN / PNP Proximity	RPM
6	MPM-6004	4	NPN / PNP Proximity	MPM
7	RS-6004	4	RS-485	Numeric Value
8	LC-9004	6 + 4	NPN / PNP Proximity	Total Length & MPM
9	MHT-9044	4 + 4	PT-100 + RH Sensor	Temperature & Humidity
10	PC-6006	6	NPN / PNP Proximity	Count
11	RS-6006	6	RS-485	Numeric Value
12	PTC-8004 (8 Inch Display)	4	4-20mA/0-10V/0-20mA DC J / K / PT-100	Process Value (-999 to 9999)/ Temperature

Worldwide Presence



America & Oceania

Australia
Mexico

Africa

Egypt
Kenya
Nigeria
Tunisia
Uganda

Asia

Bahrain
Bangladesh
India
Indonesia
Iraq
Kuwait
Malaysia
Maldives
Myanmar
Nepal
Oman
Qatar
Saudi Arabia
Singapore
UAE
Vietnam



Multispan Control Instruments pvt ltd
72B Vatva GIDC phase 1 Ahmedabad GJ 382445 INDIA
Phone +91-79-40029250 , +91-7623001206
marketing@multispanindia.com www.multispanindia.com



ScanQRcodetodownloadE-Catalog